

# Minude Recessed 56 1x IP54 LED Medium DE

136500XX\_136501XX

1

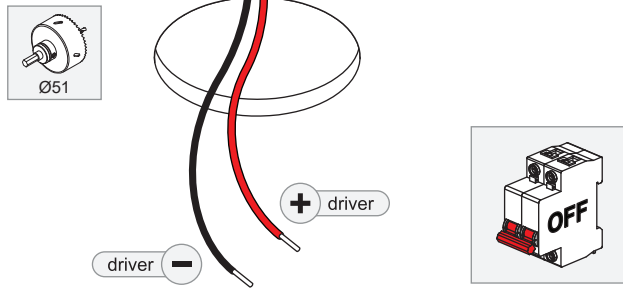

ELECTRICAL SPECS LED-FIXTURE			
Drive Current (mA)	Forward Voltage		Power (W)
	min (Vf)	max (Vf)	
350	14,8	18,0	5,7
500	15,2	18,6	8,5
+ RED		- BLACK	

For serial connection, respect polarity!  
Not suited for connection to mains voltage.  
Combine with a Modular LED-driver.

## Minimum volume requirement

With driver in false ceiling:

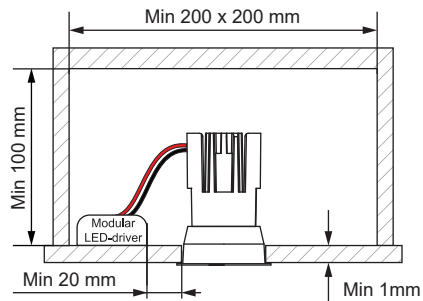

In concrete:

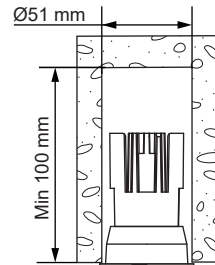

2

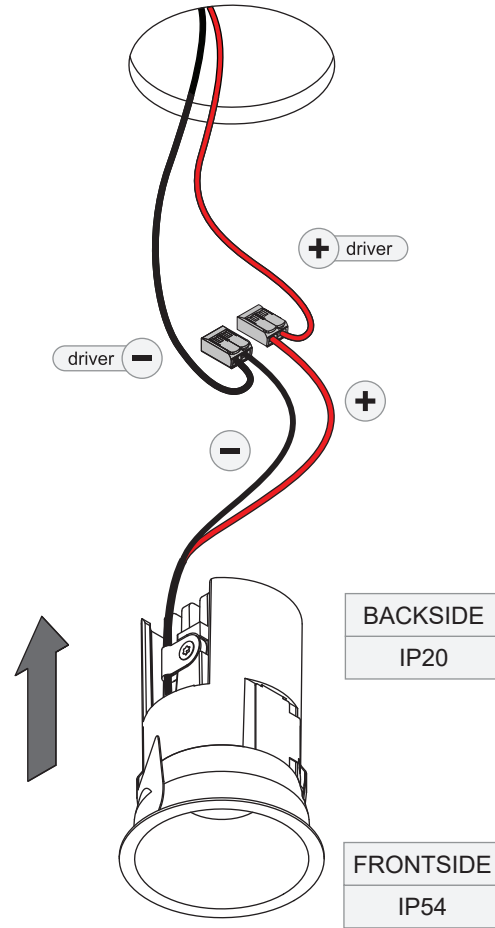

3

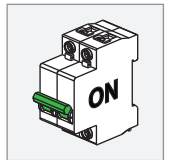
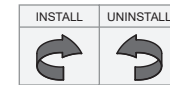
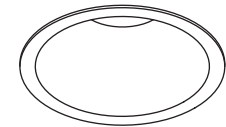

Replace protective shield when broken. The luminaire shall only be used complete with its protective shield.  
Reference number: 1014378



## LIGHT SOURCE - DO NOT TOUCH LED

Touching the LED can result in permanent damage of the light source. The light source and/or driver contained in this luminaire shall only be replaced by the manufacturer or his service agent or a similar qualified person.



## PREVENTING ELECTROSTATIC DAMAGE

A discharge of static electricity may damage sensitive components. Therefore do not touch the LED nor the stripped parts of the wires with bare hands. Always be properly insulated by using ESD gloves.

## DRIVERS & ACCESSORIES

For latest version of driver matrix and available accessories check [www.supermodular.com](http://www.supermodular.com) or connect with your sales contact.

