

LED Gear 48V 120W - DIN RAIL

12407530

WIRING diagram

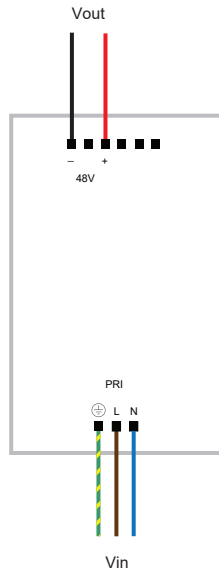

Wiring

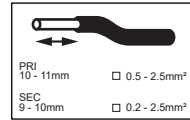

Dimensions

mm [inch]

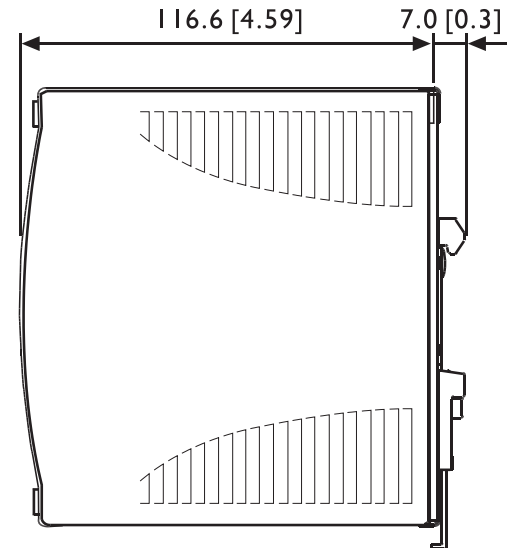
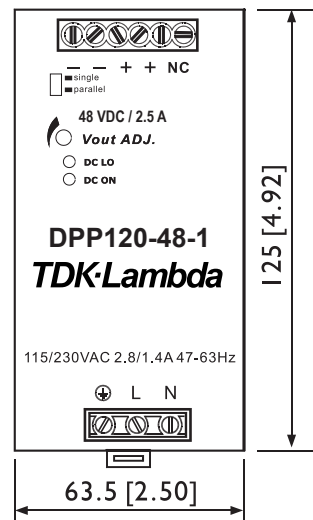

Rated Voltage

90-132VAC / 180-264VAC (auto select)

Frequency

47...63 Hz

Output Voltage

48V

Power

120 W

Temperature

Ta = -40°C...+71°C

max. Efficiency

87 %

Reference Norms

EN 61000-3-2
IEC 60068-2-6
IEC 60068-2-27
EN 55022 class B
UL508 Listed
UL60950-1
EN60950-1