

Casambi track 48V remote dim module

13470302

1 PHOTO AND DIMENSIONS

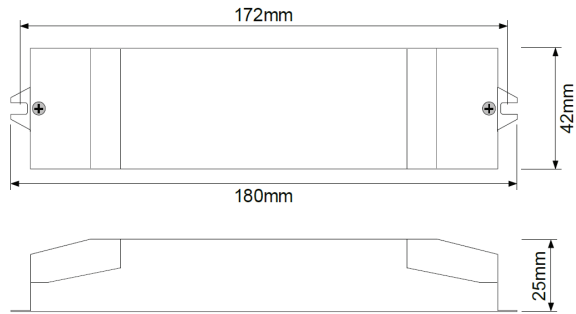

2 DESCRIPTION

- The EN1612 Bluetooth bridge was conceived and developed to control lamps with DALI drivers via mobile devices
- The interface app that generates the Bluetooth signal is used on a compatible mobile device
- The signal is received and processed by the bridge that generates the appropriate DALI signal
- It is possible to control up to 64 devices (lamps - control gear) divided into 8 groups

3 FEATURES

- Power supply from 24Vdc to 48Vdc polarized
- Fuse on board and protected against voltage peaks
- The bridge generates the DALI line and commands compatible according to the IEC 62386 standard (not optoisolated)
- Possibility to connect up to 64 DALI devices (control gear)
- The lamps are controlled by DALI commands using the "group" method, each lamp programmed to a specific group will respond to the commands received.

4 TECHNICAL SPECIFICATIONS

<i>Feed</i>		<i>Absorbed power</i>	<i>Output DALI current</i>	<i>Ambient working temperature</i>	
Min	Max	Max	Max	Min	Max
24 Vdc	48 Vdc	10W	250 mA	-20°C	+45°C

5 WORKING PRINCIPLE

- Install the Casambi app, for information consult the Casambi website. The device will be recognized by the app as EN1612
- The Casambi app uses 2 network modes:
 - NETWORK Classic ONLY the first 4 slides can be used
 - NETWORK Evolution it is possible to use and manage all 8 slides -> Advised using a Evolution network
- The device uses the DIRECT ARC group control to control the lamps
- Through the main icon it is possible to control all the devices simultaneously, by pressing and holding the icon it is possible to use the slides to control each single group
- When installing the product, the lamps must be programmed to the desired group either with automatic programming or with a DALI programmer

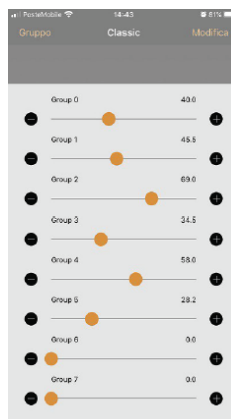

6 AUTOMATIC PROGRAMMING

- Each time the EN1612 is switched on, it looks for new lamps (without address) connected to the line and if it finds them it assigns an address and a group in a sequential way

DRIVERS & ACCESSORIES

For latest version of driver matrix and available accessories check www.supermodular.com or connect with your sales contact.

Casambi track 48V remote dim module

13470302

6.1

- Power disconnected
- Connect the new lamp

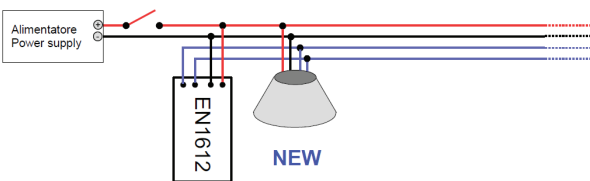

6.2

- Power the devices
- Wait 5 seconds

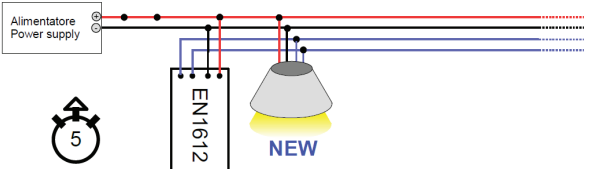

6.3

- The lamp will be programmed to group 0 FIRST SLIDE

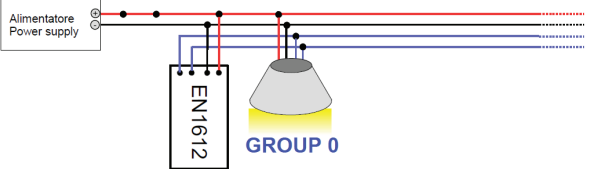

6.4

- Disconnect power
- Add a new lamp to the line

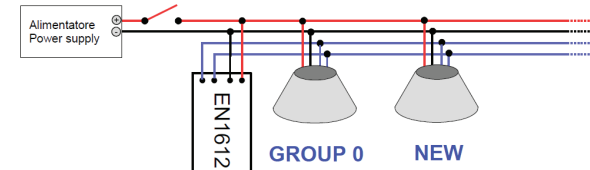

6.5

- Power the devices
- Wait 5 seconds

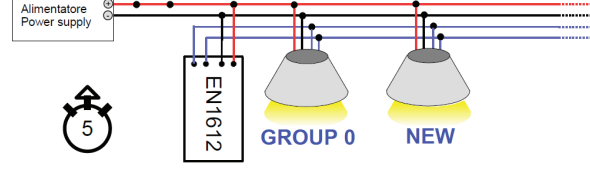

6.6

- The new lamp is programmed in group 1

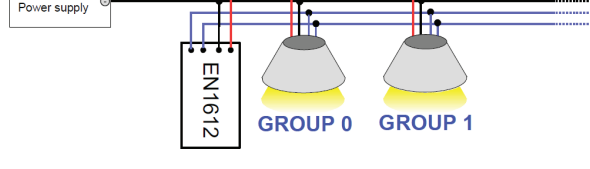

Disconnect power and proceed with the next lamps to be programmed, each new lamp will be programmed to the next group.
When programming the ninth device the assigned group will be 0, the tenth device will be programmed to group 1 and so on.

If you need to program MORE lamps to the SAME GROUP, simply make sure that the lamps programmed with the previous group are connected to the ignition, for example:
If you want to program more lamps to group 0:

- Power disconnected
- Connect the first lamp to be programmed

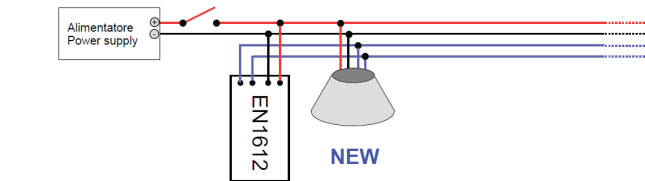

6.7

- Power the track
- Wait 5 seconds

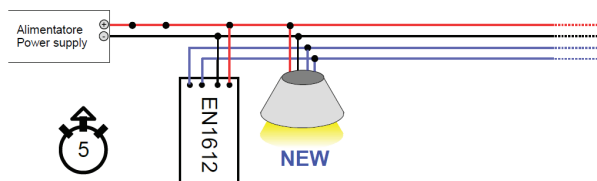

6.8

- The lamp is programmed to group 0
- Remove power,
- Remove the programmed lamp

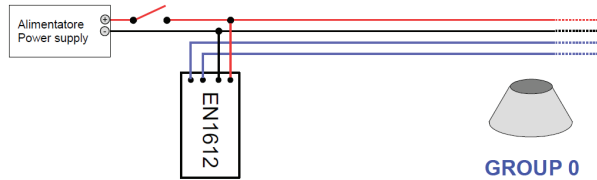

6.9

- Connect another

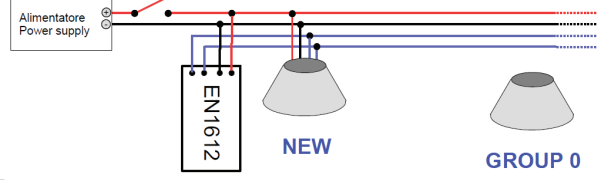

6.10

- Power up the track
- Wait 5 seconds
- The lamp is programmed to group 0

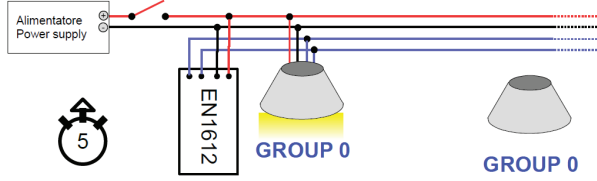

And so on, repeating this operation we would have multiple lamps programmed to group 0.
If you want to program more lamps to group 1, it will be necessary to always keep a lamp already programmed in group zero connected to the track and repeat the operation described above for all the lamps to be programmed in group 1.

DRIVERS & ACCESSORIES

For latest version of driver matrix and available accessories check www.supermodular.com or connect with your sales contact.

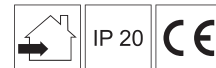

Casambi track 48V remote dim module

13470302

7 PROGRAMMING WITH EXTERNAL DALI PROGRAMMER

Use a master DALI device program to define the group of each lamp.

By programming to group 0 the device executes the command given by the first slide.

By programming to group 1 the device executes the command given by the second slide and so on up to the seventh group which corresponds to the eighth slide.

When programming with a group greater than seven, the lamp will not receive any command.

8 ATTENTION

By connecting and powering the track without programming, the EN1612 will program all the new lamps in a RANDOM mode. If it is necessary to carry out a new programming, it is necessary BEFORE carrying out a reset of the lamps (delete assigned group).



RESET OF LAMPS (cancellation of DALI group assigned to lamps)

The following procedure allows you to reset all the lamps connected to the track by deleting the assigned address and group and returning the lamps to the factory conditions. Using the main icon, press to turn on and off all devices 20 consecutive times.

During the sequence the lights turn on and off, after the twentieth consecutive command the lights cannot be controlled to indicate that the lamps have been reset successfully.

CASAMBI

www.casambi.com

Connect device to a Casambi network by using the Casambi App which can be downloaded from iOS App Store or Google Play Store.



Surrounding materials, obstructions (walls, concrete, metal,...) and other wireless signals can have a negative influence on the casambi wireless signal range. Always check on site circumstances for optimal signal quality.



For more information, support and troubleshooting about the Casambi technology please visit:
<https://support.casambi.com/support/solutions>

Advised to use this device in an Evolution network

DRIVERS & ACCESSORIES

For latest version of driver matrix and available accessories check www.supermodular.com or connect with your sales contact.