

Qbini Frame 3X

141730XX

Scan for installation video or go to supermodular.com/en/qbini-frame/

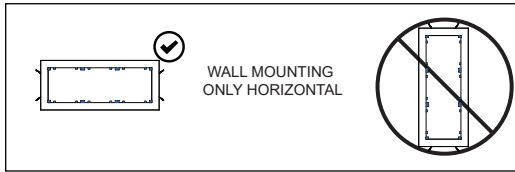

USE INCLUDED CARDBOARD TEMPLATE TO CUT SQUARE HOLE

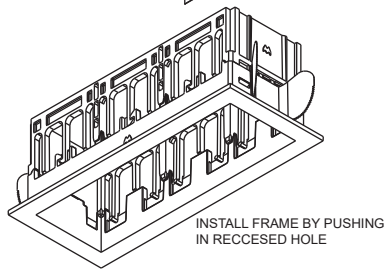
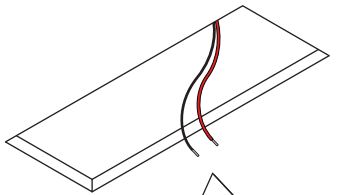
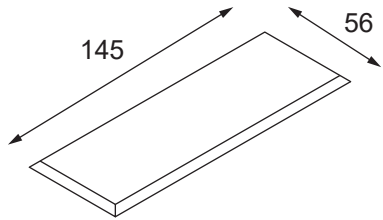
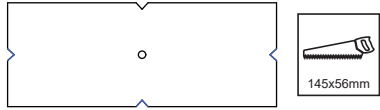

INSTALL FRAME BY PUSHING IN RECESSED HOLE

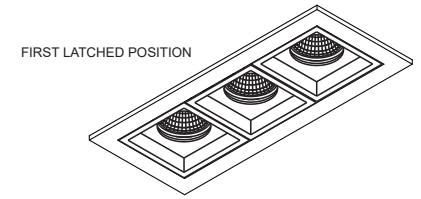
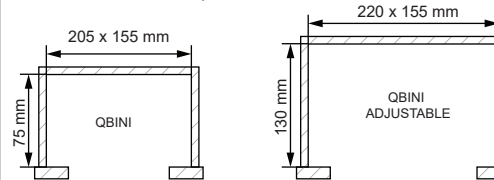
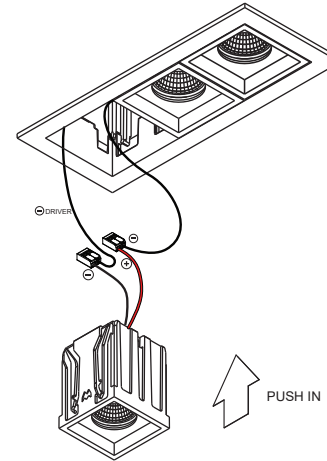
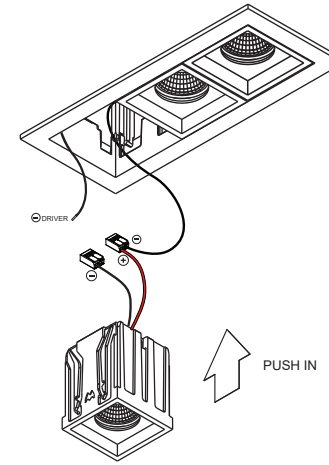
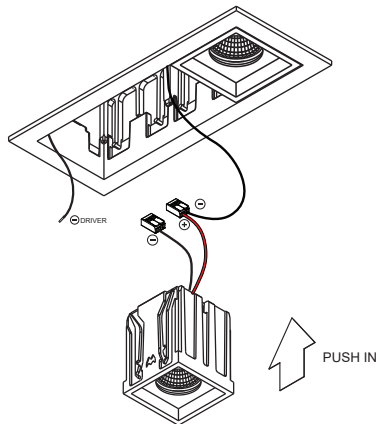
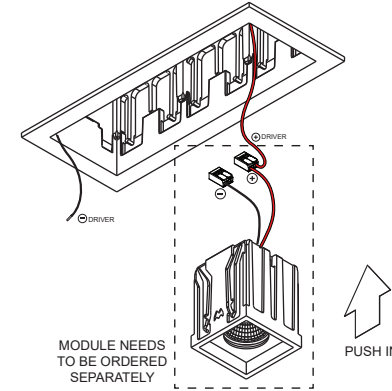
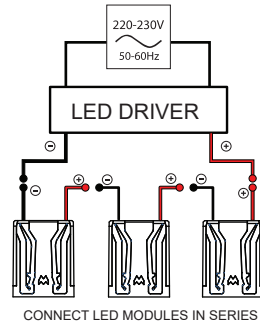

FIRST LATCHED POSITION

1

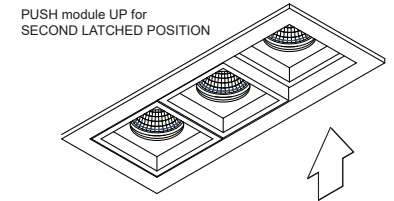

PUSH module UP for SECOND LATCHED POSITION

2

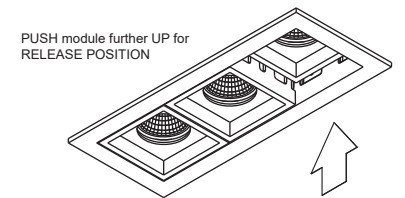

PUSH module further UP for RELEASE POSITION

3

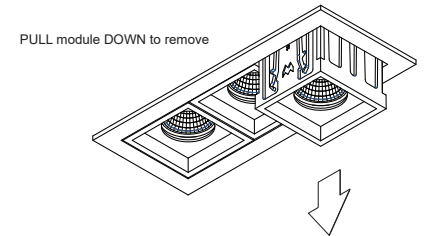

PULL module DOWN to remove

4

