

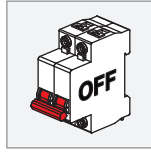

1 REMOVE COVER AND MOUNT ON CEILING

220-230V
50-60Hz
N ⊕ L



SCREWS NOT INCLUDED

max Ø5.5 mm

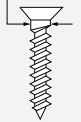

max Ø9.5 mm

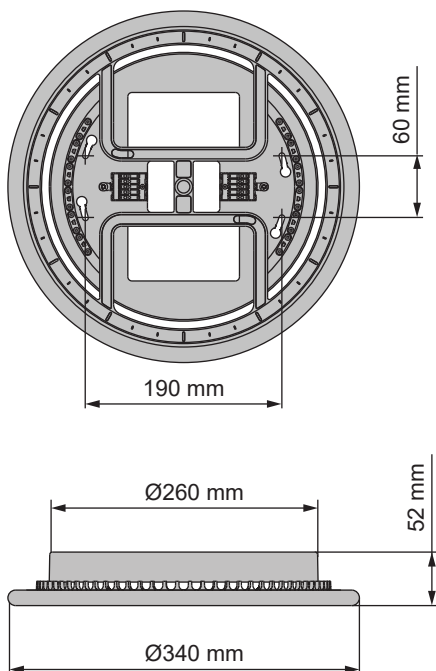
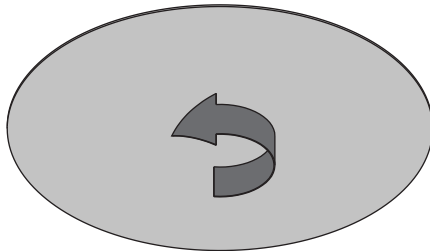
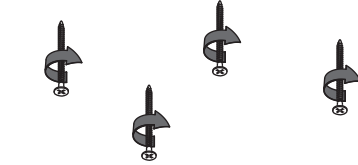
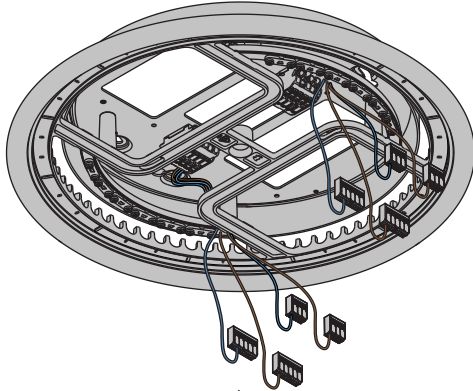

2 CONNECT PRIMARY WIRES

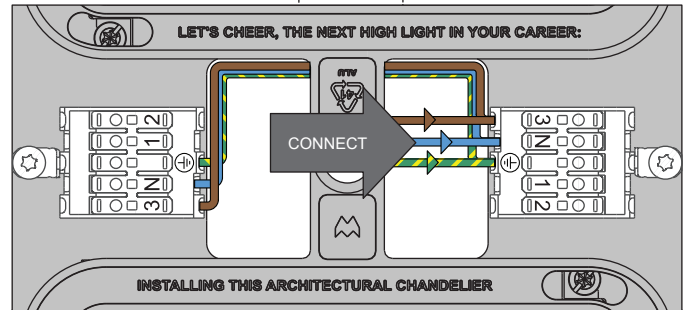
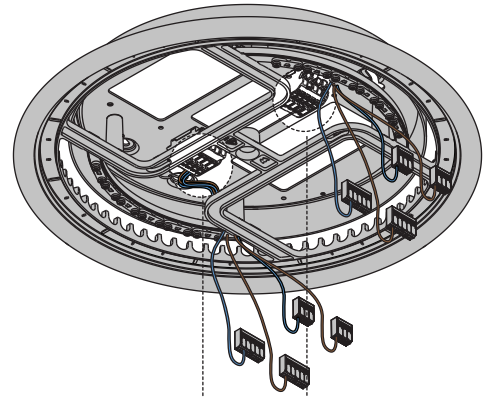

9mm
0.5 - 2.5mm²
20 - 14 AWG

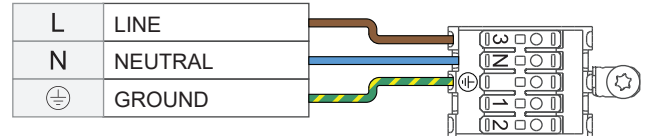

Kompas Ceiling Base Ø340 GE

135706XX

4 CONNECT FIXTURES FOR KOMPAS

MAX 12 FIXTURES
CAN BE CONNECTED

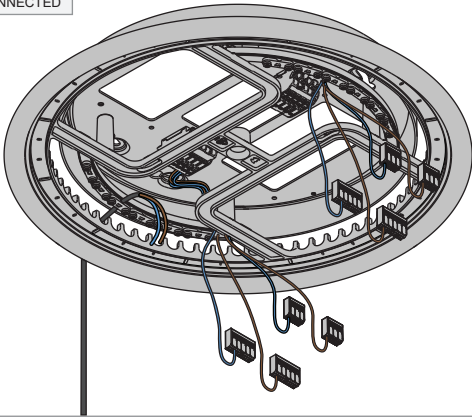

4.A LOOSEN STRAIN RELIEF

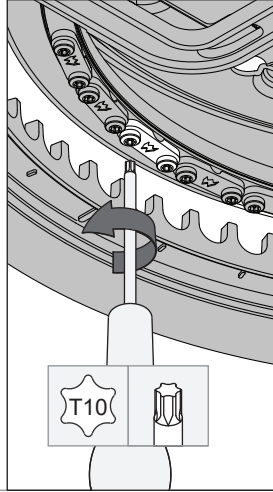

4.B GUIDE CABLE

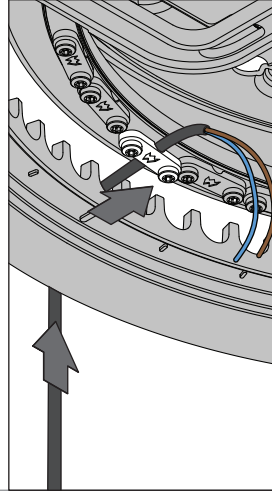

4.C FIX STRAIN RELIEF

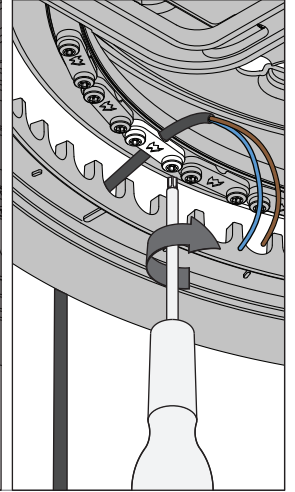

5 ELECTRICAL CONNECTION

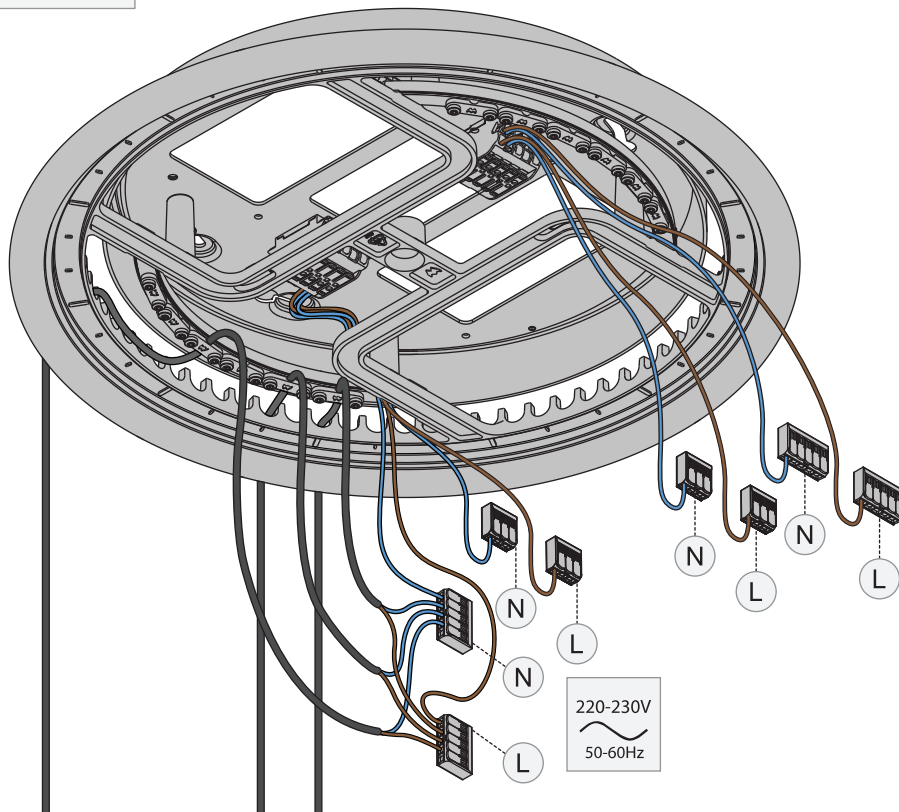

6 CLOSE COVER

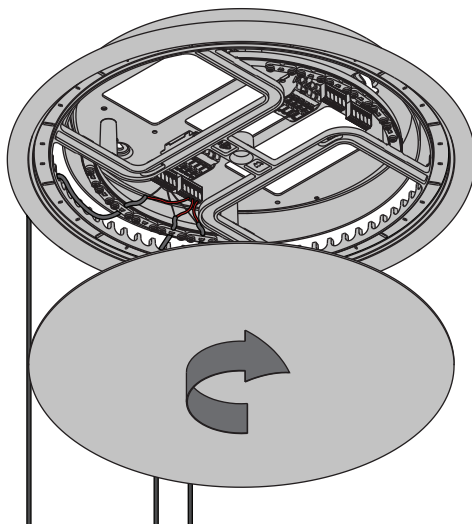

7 FINISHED

