

# Mini multiple for 2x LED GE

131301XX

## CEILING

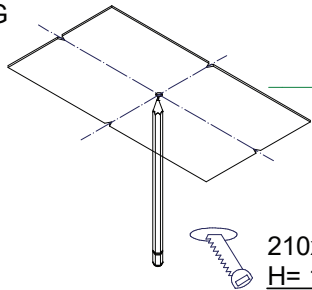

210x110  
H= 120

Conbox has to combined with gypkit !!!  
10400230+10420230

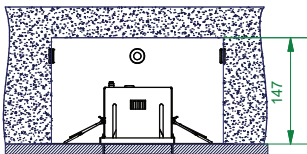
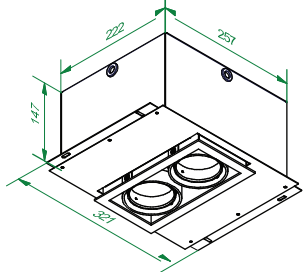

Gypkit : 10420230 Mini-multiple 2x gypkit

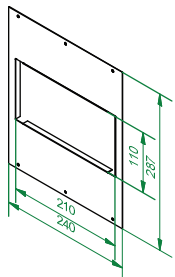
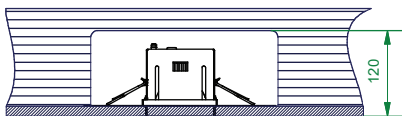

Don't connect the gear to 230V before the LEDs are connected to the gear!

## CEILING HOLE

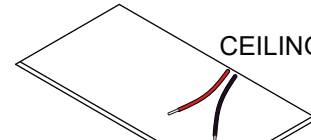

go to the + of the Led gear  
go to the - of the Led gear

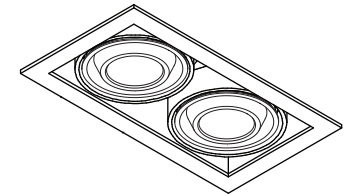
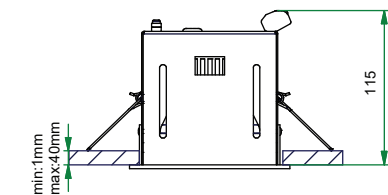
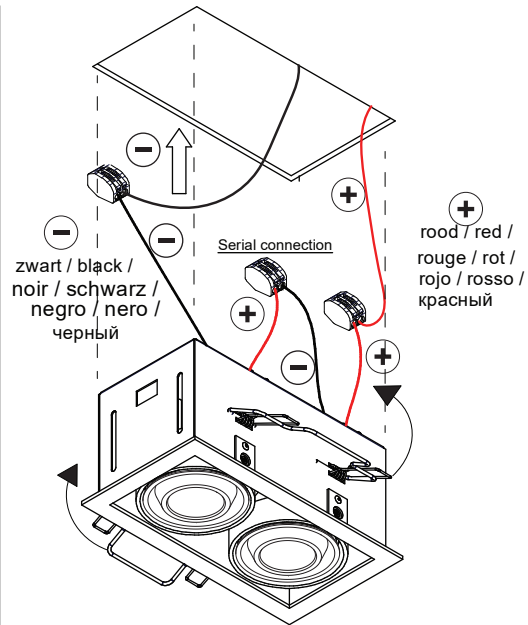
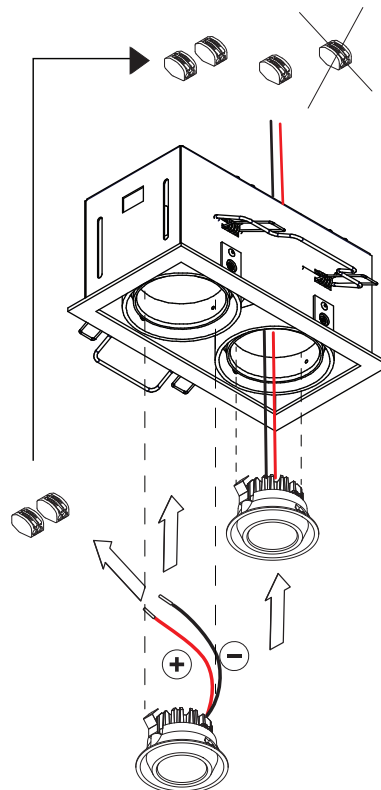

CAN BE USED WITH  
Drivers:  
see driver matrix - latest version on website  
[www.supermodular.com](http://www.supermodular.com) or check sales contact

