

Mini multiple for 1x LED GE

131300XX

CEILING

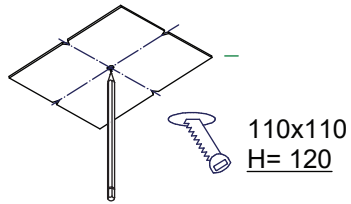

Conbox has to be combined with gypkit !!!
10400130+10420130

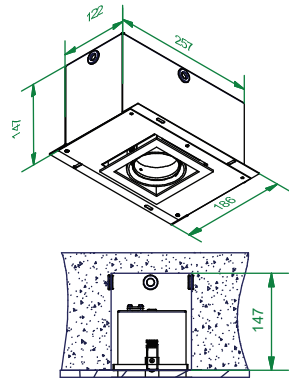

Gypkit :10420130 Mini-multiple 1x gypkit

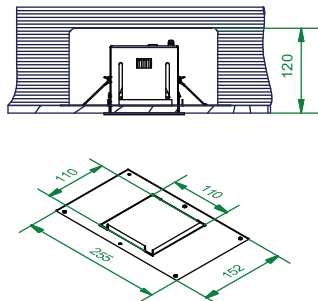

Don't connect the gear to 230V before the LEDs are connected to the gear!

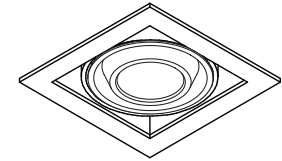
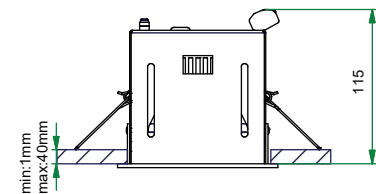
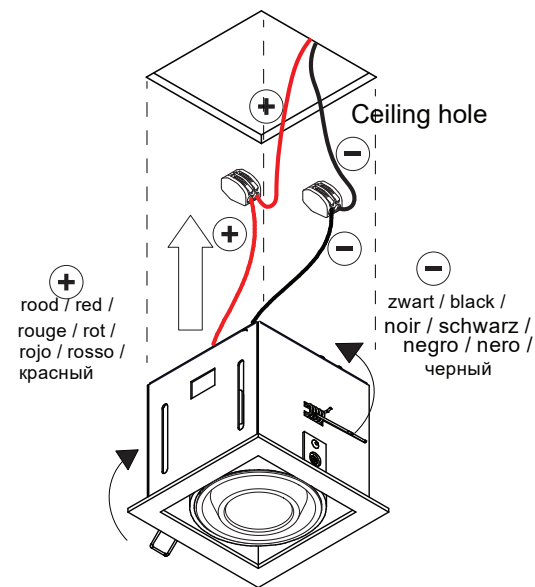
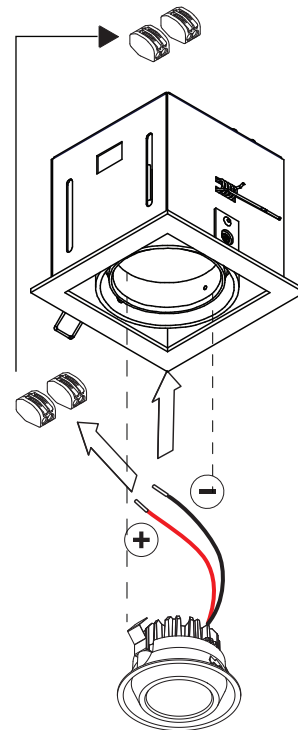
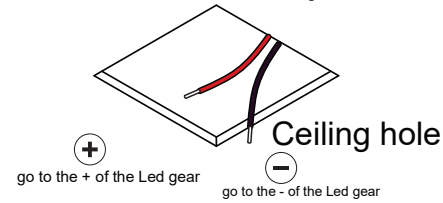

CAN BE USED WITH
Drivers:
see driver matrix - latest version on website
www.supermodular.com or check sales contact

