

Smart SBD 82 DALI 1-10V/PDGI for 2xLED

125151XX_125152XX

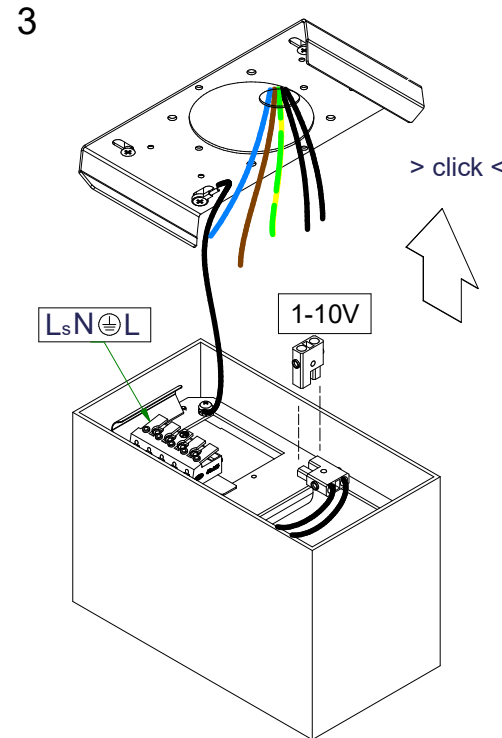

Push Dim:

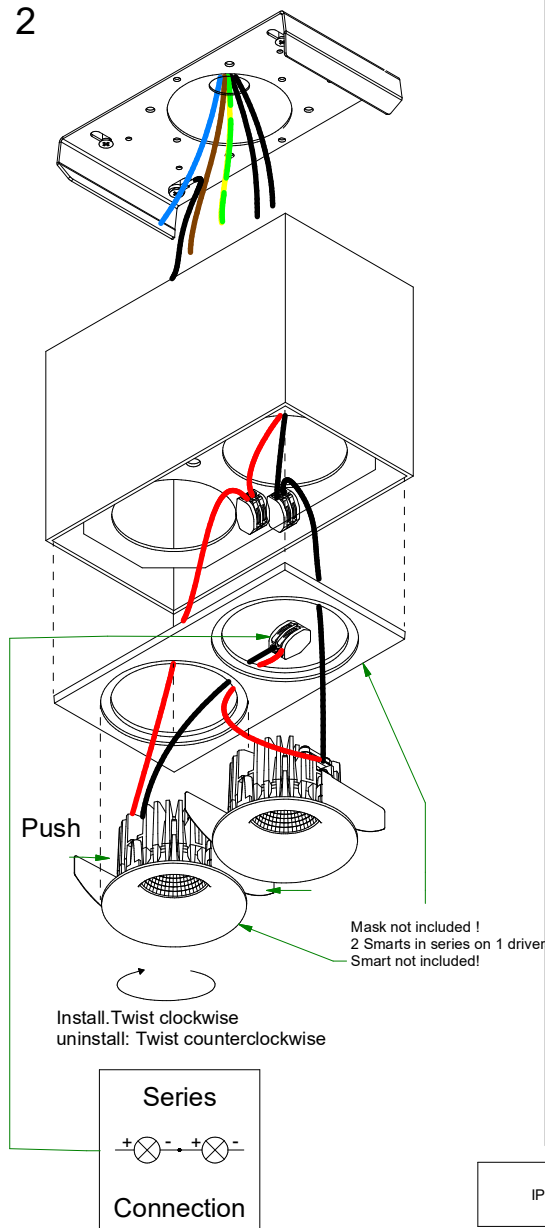
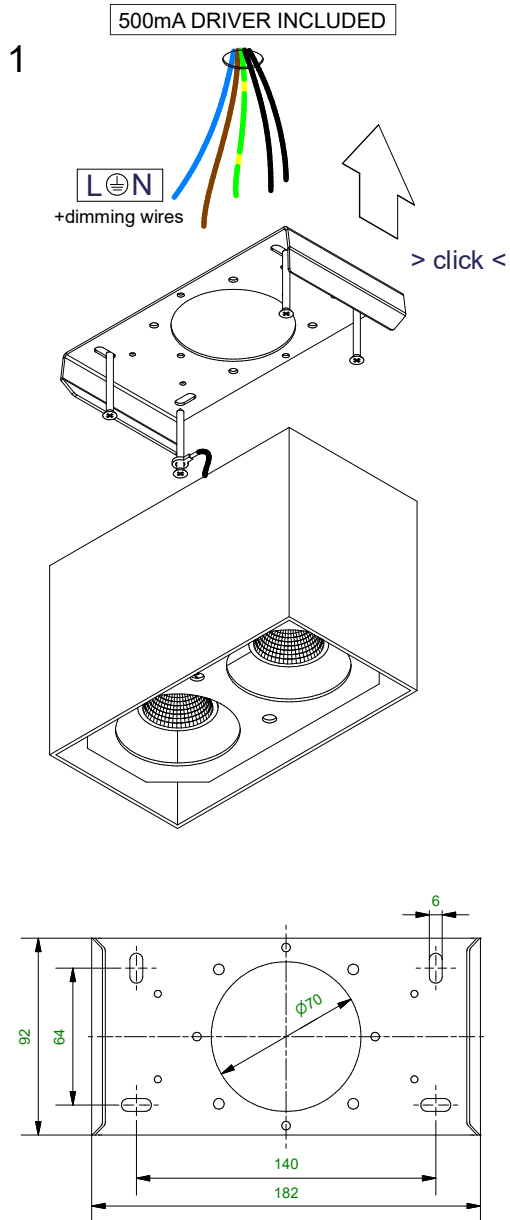
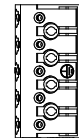

- 2: not used
- 1: L (Live) earth
- N (Neutral)
- 3: Ls (Switched Live)

Dali

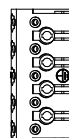

- 2: dali
- 1: dali earth
- N (Neutral)
- 3: L (Live)

1-10V Dimming:

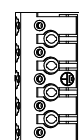

- 2: not used
- 1: L (Live) earth
- N (Neutral)
- 3: not used



red = +
black = -

Sample 1-10V wiring diagram:

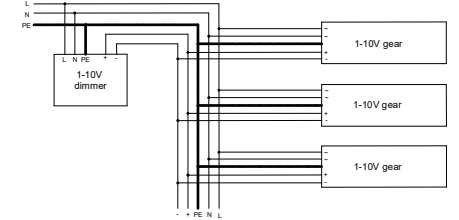

Sample PushDim wiring diagram:

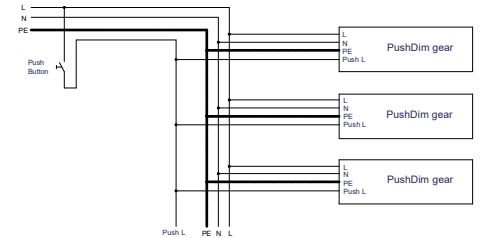

Sample DALI wiring diagram:

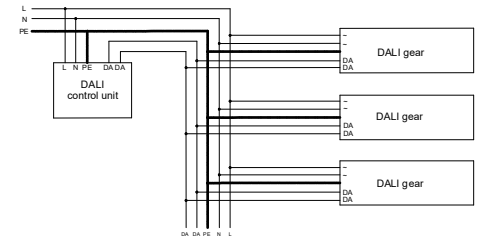

CAN BE USED WITH:
Smart 82 (IP*) LED GE
Smart 82 adjustable LED GE

MUST BE USED WITH:
Smart mask 82 2x

CAN NOT BE USED WITH:
Smart 82 (IP) warmdim LED GE
Smart 82 adjustable warmdim LED GE

*in combination with Smart Surface box = IP20

IP20			230V / 50-60Hz		1-10V	Push	DALI			
------	--	--	----------------	--	-------	------	------	--	--	--