

M-LED 111 GE

11298XXX-B1

| ELECTRICAL SPECS LED-FIXTURE | | | |
|------------------------------|-----------------|----------|-----------|
| Drive Current (mA) | Forward Voltage | | Power (W) |
| | min (Vf) | max (Vf) | |
| 350 | 28,3 | 32,9 | 10,7 |
| 500 | 29,0 | 33,6 | 15,7 |
| 700 | 29,7 | 34,5 | 22,5 |
| + RED | | - BLACK | |

For serial connection, respect polarity!
Not suited for connection to mains voltage.
Combine with a Modular LED-driver.

CONSULT YOUR LUMINAIRE SPECIFICATIONS FOR MAXIMUM CURRENT SETTING

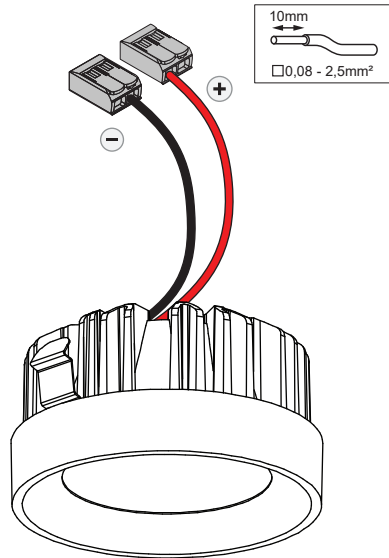

 Replace protective shield when broken. The luminaire shall only be used complete with its protective shield. Reference number: 1009392

 **LIGHT SOURCE - DO NOT TOUCH LED**
Touching the LED can result in permanent damage of the light source. The light source contained in this luminaire shall only be replaced by the manufacturer or his service agent or a similar qualified person.

 **PREVENTING ELECTROSTATIC DAMAGE**
A discharge of static electricity may damage sensitive components. Therefore do not touch the LED nor the stripped parts of the wires with bare hands. Always be properly insulated by using ESD gloves.

DRIVERS & ACCESSORIES
For latest version of driver matrix and available accessories check www.supermodular.com or connect with your sales contact.

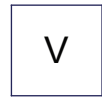

Volt
Volts
Volts
Volt
Vollto
Volt
Вольт
فولت

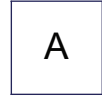

Ampère
Ampères
Amperes
Ampere
Amperio
Ampere
Ампер
أمبير

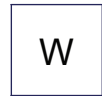

Watt
Watts
Watts
Watt
Vatio
Watt
Ватт
وات



Gelijkspanning
Alimentation en courant alternatif
DC power
Gleichstrom
Corriente continua
Corrente continua
Постоянный ток
تيار متردد



Klasse 3
Classe 3
Class 3
Klasse 3
Class 3
classe 3
Класс 3
الفئة 3



Norm
Norme
Standard
Norm
Norma
Norma
Норма
قياسي



Raak de LED niet aan
Do not touch the LED
Touchez pas la LED
Berühren Sie die LED nicht
No toque el LED
Non toccare il LED
Не прикасайтесь к светодиоду
لا تلمس وحدات الأضاءة LED



Interieur gebruik
Utilisation intérieur
Innenverwendung
Interior use
Uso interior
Для использования внутри помещений
للاستخدام داخل المباني

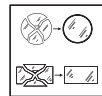

Beschermglas vervangen indien beschadigd
Remplace le verre de protection si celui-ci est endommagé
Replace protective glass cover if damaged
Schutzglas ersetzt, wenn sie beschädigt
Sostituire el vidrio protector en caso de que esté dañado
Sostituire il vetro protettivo se danneggiato
Заменить защитное стекло в случае его повреждения
استبدل غطاء الحماية الزجاجي عند تضرره

supermodular.com

For a complete international dealer list, please contact our website: www.supermodular.com

Main office Belgium

Modular Lighting Instruments
Armoedestraat 71 • 8800 Roeselare • Belgium
t + 32 51 26 56 56 • f + 32 51 22 80 04
welcome@supermodular.com

INSTALLATIE MOET GEBEUREN DOOR EEN ERKEND INSTALLATEUR
L'INSTALLATION DOIT ETRE FAITE PAR UN INSTALLATEUR COMPETENT
INSTALLATION MUST BE DONE BY A COMPETENT INSTALLER
INSTALLATION MUSS VON EINEM KOMPETENTEN INSTALLATEUR DIRCHGEFÜHRT WERDEN
LA INSTALACION DEBE HACERLA UN INSTALADOR COMPETENTE
INSTALLAZIONE DEVE ESSERE EFFETTUATA DA UN INSTALLATORE QUALIFICATO
МОНТАЖ СВЕТИЛЬНИКА ДОЛЖЕН ВЫПОЛНЯТЬСЯ КВАЛИФИЦИРОВАННЫМ СПЕЦИАЛИСТОМ

يجب أن يتم التركيب من قبل مُركّب مختص



MODULAR
LIGHTING —
INSTRUMENTS