

Back up unit for LED 1h DE

12400010

WIRING DIAGRAMS

NON-MAINTAINED: EMERGENCY ONLY

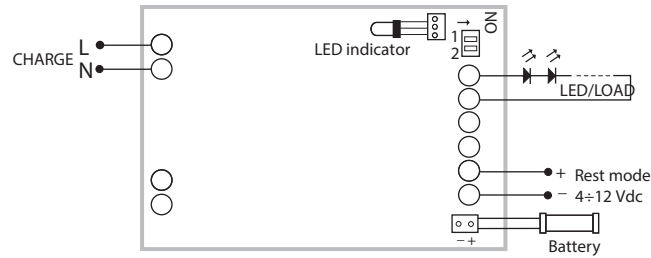

MAINTAINED: WITH EXTERNAL ELECTRONIC DRIVER

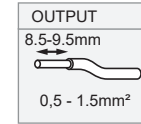
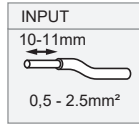
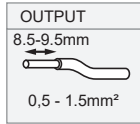
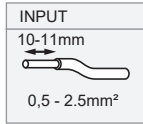
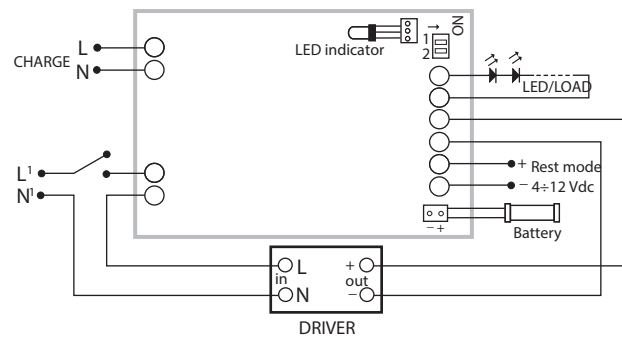

ELECTRICAL CHARACTERISTICS

NOMINAL INPUT VOLTAGE RANGE AC

220 - 240V

INPUT FREQUENCY RANGE

50...60HZ

MAXIMUM OUTPUT POWER

7W

TEMPERATURE

T_c = 80°C
T_a = 0°C...+60°C

TYPICAL INRUSH CURRENT

27A 250µs

MAXIMUM PIECES ON MCB 16A TYPE B

27pc

DIMENSIONS

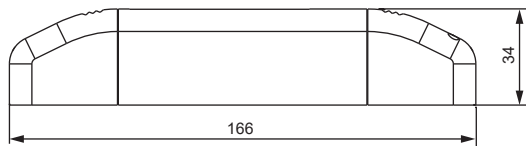
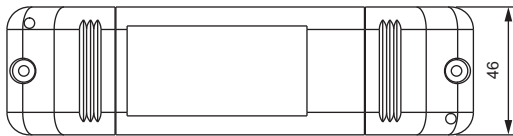

DIPSWITCH SETTINGS

100mA ... 350mA

9-58Vdc



REMARKS

- Respect polarity for installation of battery and LED luminaire.
- Max distance between emergency kit and lamp: 2 meters
- Keep batteries away from heat source.
- Do not connect any external battery charger
- In order to check the correct functionality, we recommend a charging time of about 30 hours.
- It is advisable to effect every 3 months at least one discharge and charge cycle in order to assure the maximum efficiency.
- Replace the batteries every 4 years or after 500 charge/discharge cycles.
- Please check wire diagrams before installing.
- Keep battery not connected to the emergency kit until the final installation of the system
- Do not stock battery and kit connected together.

FIXTURES & ACCESSORIES

For latest version of driver matrix and available accessories check www.supermodular.com or connect with your sales contact.



Back up unit for LED 1h DE

12400010

BACK-UP UNITS - EMERGENCY LIGHT OUTPUT

	Typical drive current	Emergency light output compared to light output at typical current
Chapeau Recessed Adjustable 1x LED DE	350mA	50%
Chival Wall Up/Down 292 2x LED DE	500mA	66%
Chival Wall Up/Down 292 2x LED WD DE	250mA	88%
Dent Wall Up/Down L 1x LED DE	350mA	30%
Dent Wall Up/Down M 1x LED DE	350mA	30%
Dent Wall Up/Down S 1x LED DE	350mA	75%
Duell Recessed Adjustable 1x/2x LED DE	500mA	72%
Extruded Suspended 46 1x LED DE	500mA	75%
Extruded Suspended 46 1x LED WD DE	350mA	100%
Gamin Jack 1x LED DE	500mA	75%
Gamin Jack 1x LED WD DE	350mA	100%
Hipy Round/Square Recessed 110 1x IP67 LED DE	500mA	72%
Hipy Round/Square Recessed 70 1x IP67 LED DE	350mA	100%
Hollow Recessed Adjustable 1x LED DE	500mA	72%
Impulse Square/Round Wall 1x IP44 LED DE	500mA	74%
Julien Round Floor Adjustable 1x IP54 LED DE	500mA	100%
K 120 Recessed Adjustable 120 1x LED DE	500mA	36%
K 72 Recessed Adjustable 72 1x IP55 LED DE	500mA	72%
K 77 Recessed Adjustable 77 1x LED DE	500mA	72%
Lotis Round Recessed 82 1x (Concrete) M-LED DE	500mA	72%
Lotis Round Recessed 86 1x IP55 M-LED DE	500mA	72%
Lotis Round Recessed Adjustable 97 1x (Concrete) M-LED DE	500mA	72%
Marbul Recessed Adjustable 115 1x/2x LED DE	500mA	72%
Marbul Recessed Adjustable 115 1x/2x LED WD DE	350mA	51%
Marbul Suspended (Adjustable) 109 1x LED DE	500mA	72%
Marbul Suspended (Adjustable) 109 1x LED WD DE	350mA	51%
Marbulito Jack Adjustable/Suspended 41 1x LED DE	500mA	75%
Marcel Recessed Adjustable 1x/2x/3x LED DE	500mA	36%
Medard Jack Adjustable 42 1x LED DE	700mA	50%
Medard Jack Adjustable 42 1x LED WD DE	350mA	100%
Medard Recessed 42 1x LED DE	500mA	75%
Medard Recessed 42 1x LED DE	350mA	100%
Medard Recessed 70 1x LED DE	500mA	72%
Medard Recessed 70 1x LED DE	350mA	51%
Medard Semi-Recessed Adjustable 42 1x LED DE	700mA	50%

	Typical drive current	Emergency light output compared to light output at typical current
Medard Semi-Recessed Adjustable 42 1x LED WD DE	350mA	100%
Medard Semi-Recessed Adjustable 70 1x LED DE	500mA	38%
Medard Semi-Recessed Adjustable 70 1x LED WD DE	350mA	51%
Medard Stretched Semi-Recessed Adjustable 70 1x/2x LED DE	500mA	38%
Medard Stretched Semi-Recessed Adjustable 70 1x/2x LED WD DE	350mA	51%
Mini-Multiple Recessed (Trimless) Adjustable 1x LED DE	500mA	72%
Mini-Multiple Recessed (Trimless) Adjustable 2x LED DE	500mA	72%
Mini-Multiple Recessed (Trimless) Adjustable 3x LED DE	500mA	72%
Mini-Multiple Recessed (Trimless) Adjustable 4x LED DE	500mA	72%
Minute Jack Adjustable/Suspended 45 1x LED DE	500mA	72%
Minute Jack Adjustable 45 1x LED Spot DE	500mA	75%
Minute Out Recessed 49 23 1x LED DE	500mA	72%
Minute Out Recessed 49 23 1x LED Spot DE	500mA	75%
Minute Recessed 56 1x LED DE	500mA	72%
Minute Recessed 56 1x LED Spot DE	500mA	75%
Minute Recessed Trimless 49 1x LED DE	500mA	72%
Minute Recessed Trimless 49 1x LED Spot DE	500mA	75%
Minute Semi-Recessed Adjustable 45 1x LED DE	500mA	72%
Minute Semi-Recessed Adjustable 45 1x LED Spot DE	500mA	75%
Minute Suspended 45 1x DE	500mA	72%
M-LED Module 50/70 1x LED DE	500mA	72%
M-LED Module 50/70 1x LED WD DE	350mA	100%
M-LED Module 111 1x LED DE	500mA	38%
Modest Recessed 74 1x IP55 LED Medium DE	500mA	74%
Nomad Surface Adjustable 2x LED DE	500mA	38%
Nomad Surface Adjustable 4x LED DE	500mA	38%
Nomad Surface Adjustable 2x LED AR111 DE	500mA	33%
Nomad Surface Adjustable 4x LED AR111 DE	1000mA	17%
Placebo Suspended Up/Down 60 1x LED DE	350mA	100%
Placebo Suspended Up/Down 60 1x WD LED DE	350mA	100%
Pupil Recessed Adjustable 72 1x LED DE	700mA	54%
Pupil Recessed Adjustable 72 1x LED WD DE	350mA	100%
Qbini Fix/Adjustable/Asy Recessed 1x LED DE	500mA	75%
Qbini Fix/Adjustable/Asy Recessed 2x LED DE	500mA	75%
Qbini Fix/Adjustable/Asy Recessed 3x LED DE	500mA	50%

	Typical drive current	Emergency light output compared to light output at typical current
Qbini Fix/Adjustable/Asy Recessed 4x LED DE	500mA	35%
Qbini Fix/Adjustable/Asy Recessed Trimless 1x LED DE	500mA	75%
Qbini Fix/Adjustable/Asy Recessed Trimless 2x LED DE	500mA	75%
Qbini Fix/Adjustable/Asy Recessed Trimless 3x LED DE	500mA	50%
Qbini Fix/Adjustable/Asy Recessed Trimless 4x DE	500mA	35%
Qbini General 2x LED DE	500mA	100%
Qbini General 4x LED DE	500mA	55%
Rektor Semi-Recessed Adjustable 78x78 1x LED DE	500mA	35%
Rektor Semi-Recessed Adjustable 78x78 1x LED WD DE	350mA	51%
Rektor Semi-Recessed Adjustable 54x46 1x LED DE	350mA	50%
Rektor Semi-Recessed Adjustable 54x46 1x LED WD DE	350mA	100%
Shellby Recessed (Trimless) 176/184 1x LED DE	500mA	72%
Shellby Recessed (Trimless) 176/184 1x LED WD DE	350mA	51%
Smart Cake/Kup/Lotis/Lotis Asy Recessed 48 1x LED DE	500mA	75%
Smart Cake/Kup/Lotis/Lotis Asy Recessed 48 1x HO IP55 LED DE	500mA	75%
Smart Cake/Kup/Lotis Recessed (Adjustable) 82 1x LED DE	500mA	72%
Smart Cake/Kup/Lotis Recessed (Adjustable) 82 1x LED WD DE	350mA	100%
Smart Cake/Kup/Lotis Recessed 115 1x (IP54) (Diffuse) LED DE	500mA	35%
Smart Cake/Kup/Lotis Recessed Adjustable 115 1x LED DE	500mA	72%
Smart Cake/Kup/Lotis Recessed Adjustable 115 1x LED WD DE	350mA	51%
Smart Cake/Kup/Lotis Recessed 160 1x IP55 (Diffuse) LED DE	900mA	25%
Stove Surface Adjustable 118 1x LED DE	350mA	50%
Tetrix 1x LED DE Frame Round 74	500mA	75%
Tetrix 1x LED Spot DE Frame Round 74	500mA	75%
Tetrix 1x LED WD DE Frame Round 74	250mA	72%
Tetrix 1x LED DE Recessed Ring 62 Trimless	500mA	75%
Tetrix 1x LED Spot DE Recessed Ring 62 Trimless	500mA	75%
Tetrix 1x LED WD DE Recessed Ring 62 Trimless	250mA	72%
Thimble Recessed (Trimless) (Adjustable) 70/74 1x DE	500mA	72%
Thimble Recessed (Trimless) (Adjustable) 70/74 1x Spot DE	500mA	75%

UNIT DOES NOT FIT THROUGH CUTOUT HOLE OF FIXTURE
 DEPENDING MOUNTING ACCESSORY UNIT MAY NOT FIT THROUGH CUTOUT HOLE

FIXTURES & ACCESSORIES
 For latest version of driver matrix and available accessories check www.supermodular.com or connect with your sales contact.



