

Date
Customer
Project
Type

SLD75 Recessed

SLD75 is a completely customisable solution, guaranteeing the perfect size for your setting. With a low UGR, our LED module, combined with different lenses – prismatic polycarbonate diffuser or PMMA diffuser – brings you the ideal solution for office lighting. SLD75 fitted with standard poly lenses is perfect for general lighting and even comes standard with pre-set dimming.

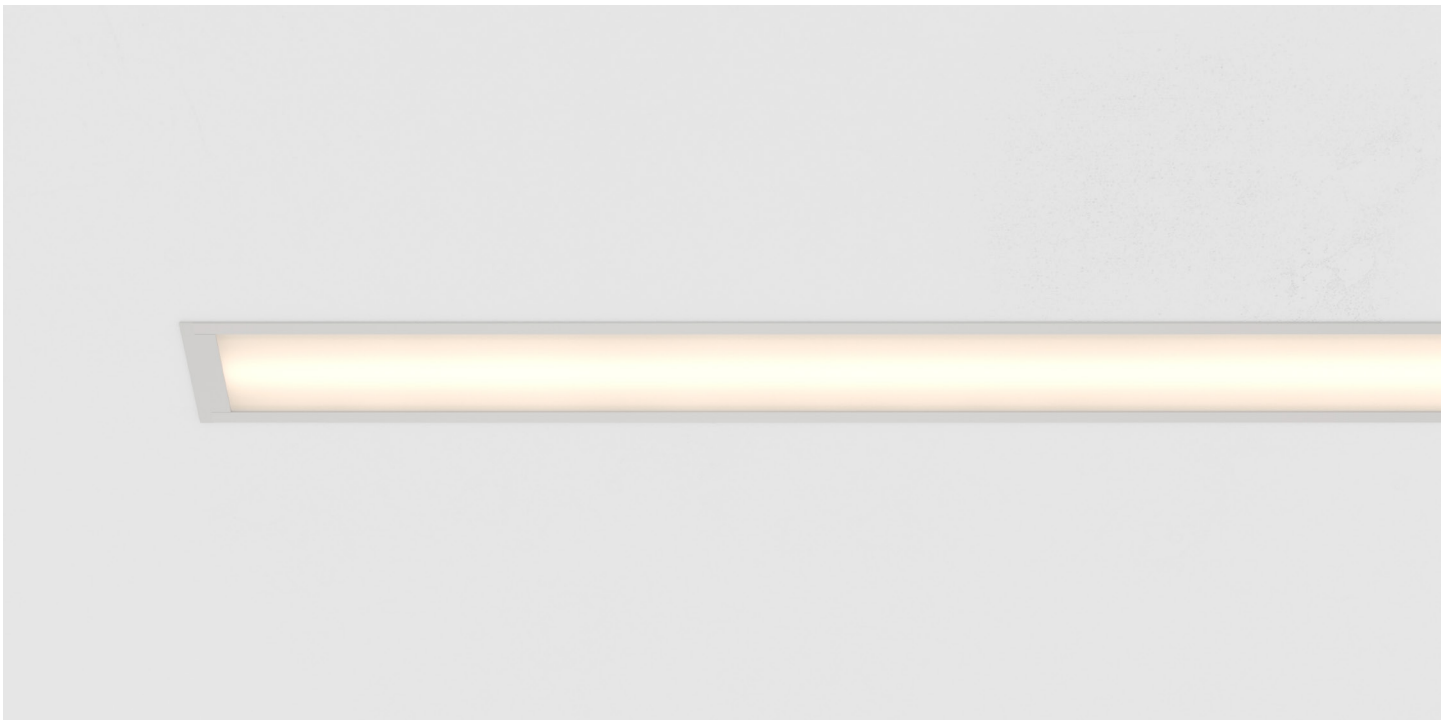

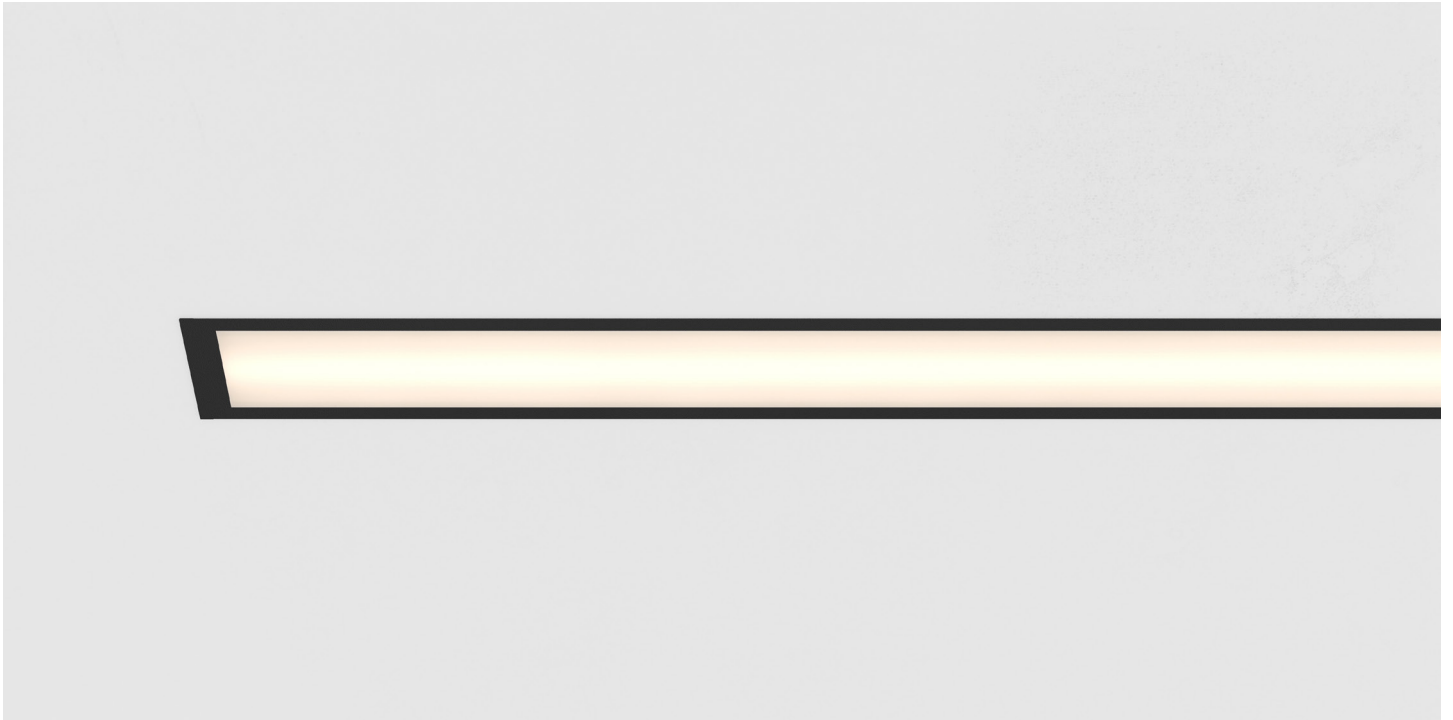
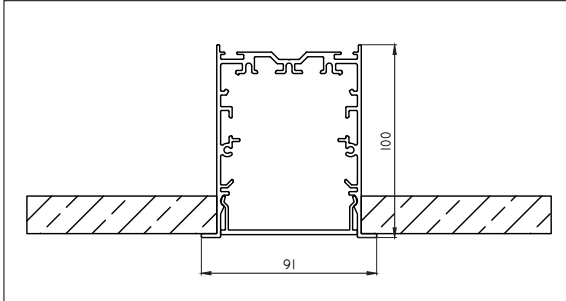

SLD75

Base Profile

Dimensions	100mm x 75mm (h x w)
Mounting Depth	113mm
Base thickness	1.5mm
Mounting	Ceiling
Indoor/Outdoor	Indoor
Finish	Anodised: aluminium Fine structured scratch resistant powder coating: black, white
IP rating	IP20
Glow Wire Test	960°
CRI	90+
Warranty	5 years

Profile Cover

Finish	Anodised: aluminium Fine structured scratch resistant powder coating: black, white
--------	---

Diffusor

Type	Polycarbonate Prismatic polycarbonate PMMA
------	--

Lighting Modules

Linear Lighting module

LED type	High power LED line
Colour temperature	2700K, 3000K, 4000K
Dimming	Non-dimmable, Dali/Pushdim Available in preset dimmed version 50% Flicker-free (AM dimming)

Finish Information

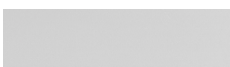

aluminium
(anodised)

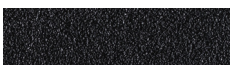

black structure
(powder coating)

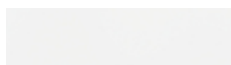

white structure
(powder coating)

Base Profile

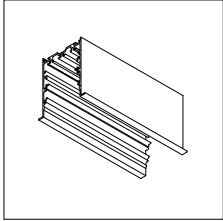

- 93552004** SLD75 PROFILE FLANGE ALU/M
- 93552032** SLD75 PROFILE FLANGE BLACK STRUC/M
- 93552009** SLD75 PROFILE FLANGE WHITE STRUC/M

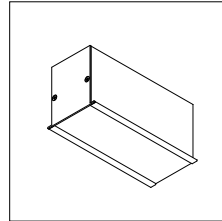

- 93552184** SLD75 FLANGE ENDPLATE EXCL. INNER FLANGE ALU
- 93552883** SLD75 FLANGE ENDPLATE EXCL. INNER FLANGE BLACK STRUC
- 93552983** SLD75 FLANGE ENDPLATE EXCL. INNER FLANGE WHITE STRUC

Profile Cover

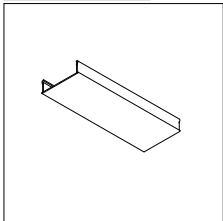

- 93550205** SLD75 COVER ALU/M
- 93550232** SLD75 COVER BLACK STRUC/M
- 93550209** SLD75 COVER WHITE STRUC/M

Connection

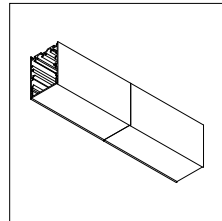

- 93550050** SLD75 CONNECTION 180°

Diffusor

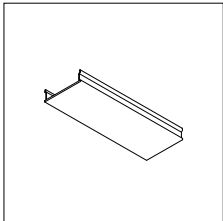

- 93550115** SLD75 POLY/M
- 93550116** SLD75 PMMA/M
- 93550118** SLD75 PRISMATIC POLY CLEAR/M

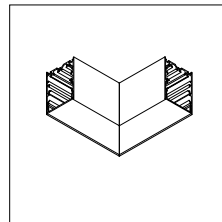

- 93550060** SLD75 CONNECTION 90°

Endplate

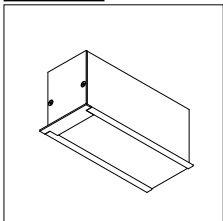

- 93552182** SLD75 FLANGE ENDPLATE INCL. INNER FLANGE ALU
- 93552881** SLD75 FLANGE ENDPLATE INCL. INNER FLANGE BLACK STRUC
- 93552982** SLD75 FLANGE ENDPLATE INCL. INNER FLANGE WHITE STRUC

Fixation / Mounting

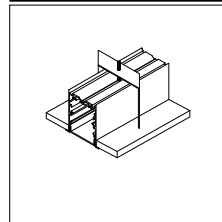

- 93550999** SLD75 RECESSED BRACKET

Electrical Supply

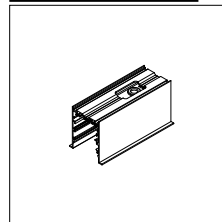

- 93550100** SLD75 HOLE FOR POWER SUPPLY 3-5P

Supplements

93000101	RAL SET UP CHARGE
93552108	SLD75 RAL SUPPL. PROFILE FLANGE/M
93550210	SLD75 RAL SUPPL. COVER/M
93550188	SLD75 RAL SUPPL. ENDPLATE
93002000	SUPPL. EXTRA CIRCUIT /M (2 STANDARD)

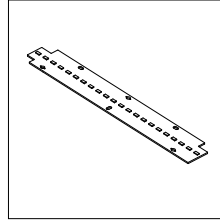

NON-DIM	-3-----
DALI/PUSHDIM	-8-----

Linear LED Fortimo LEDline

	2700K	3000K	4000K	Module length (mm)
2x	9X554502	9X554002	9X554102	560
3x	9X554503	9X554003	9X554103	840
4x	9X554504	9X554004	9X554104	1120
5x	9X554505	9X554005	9X554105	1400
6x	9X554506**	9X554006**	9X554106**	1680
7x	9X554507**	9X554007**	9X554107**	1960

Lamp type	MED POWER LED
Delivered lumens*	1580lm/m (2700K) 1624lm/m (3000K) 1674lm/m (4000K)
Connected load*	24.8W/m (2700K, 3000K, 4000K)
Efficacy*	63.7lm/w (2700K) 65.5lm/W (3000K) 67.5 lm/W (4000K)
UGR*	23
Binning	3SDCM
Lifetime	L80 B10 @50000hrs.

* values for poly, calculated via 5x LEDline

SUPPLEMENTS

*93551011 PROFILE EMERGENCY PACK 3H

*only for 2700K, 3000K, 4000K in 3x and 4x

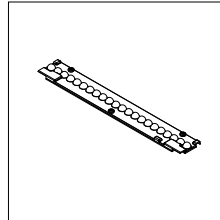

NON-DIM	-3-----
DALI/PUSHDIM	-8-----

Linear LED Fortimo LEDline + lens 80°

	2700K	3000K	4000K	Module length (mm)
2x	9X557102	9X556002	9X556102	560
3x	9X557103	9X556003	9X556103	840
4x	9X557104	9X556004	9X556104	1120
5x	9X557105	9X556005	9X556105	1400
6x	9X557106**	9X556006**	9X556106**	1680
7x	9X557107**	9X556007**	9X556107**	1960

Linear LED Fortimo LEDline Office Compliant + lens 80°

	2700K	3000K	4000K	Module length (mm)
4x	9X558904	9X559004	9X559104	1120
5x	9X558905	9X559005	9X559105	1400
6x	9X558906**	9X559006**	9X559106**	1680
7x	9X558907**	9X559007**	9X559107**	1960

Lamp type	MED POWER LED
Delivered lumens*	2446lm/m (2700K) 2514lm/m (3000K) 2590lm/m (4000K)
Connected load*	24.8W/m (2700K, 3000K, 4000K)
Efficacy*	98.6lm/W (2700K) 101.4lm/W (3000K) 104.4lm/W (4000K)
UGR*	17
Binning	3SDCM
Lifetime	L80 B10 @50000hrs.
Remark	Combine with a prismatic poly clear to create an office compliant solution

* values for prismatic, calculated via 5x LEDline

Lamp type	MED POWER LED
Delivered lumens*	1002lm/m (2700K) 1026lm/m (3000K) 1060lm/m (4000K)
Connected load*	10W/m (2700K, 3000K, 4000K)
Efficacy*	100lm/W (2700K) 103lm/W (3000K) 106lm/W (4000K)
UGR*	19
Binning	3SDCM
Lifetime	L80 B10 @50000hrs.
Remark	Combine with PMMA to create an office compliant solution

* values for PMMA, calculated via 5x LEDline

SUPPLEMENTS

*93551011 PROFILE EMERGENCY PACK 3H

*only for 2700K, 3000K, 4000K in 3x and 4x