

Date
Customer
Project
Type

SLD35 Surface

Light lines are a beautiful way to highlight the architectural elements of a space. SLD35, formerly SL micro, can easily be your luminaire of choice for this effect. In fact, so can our entire SLD family. Available in ceiling mounted, suspended and recessed versions. SLD35 combined with IP44 ledstrip enables you to extend your light lines into damp indoor locations (such as bathrooms).

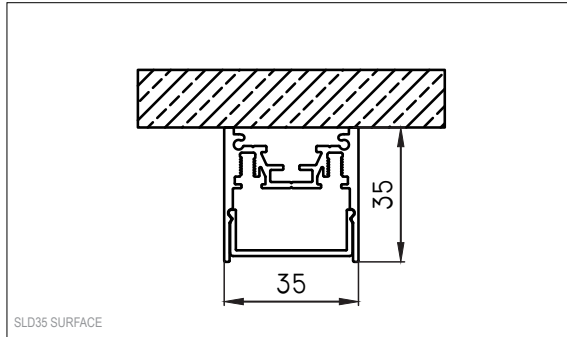



Base Profile

	SLD35	SLD35 IP
Dimensions	35mm x 35mm (h x w)	
Base thickness	2mm	
Mounting	Ceiling, Wall	
Indoor/Outdoor	Indoor	
Finish (RAL finish available on request)	Anodised: aluminium Brushed anodised: bronze, champagne, silver bronze Fine structured scratch resistant powder coating: black, white	
IP rating	IP20	IP44, only with IP44 flexible LED strip
Glow Wire Test	960°	
CRI	90+	
Warranty	5 years	

Diffusor

Type	PMMA
------	------

Lighting Modules

Linear LED Strip 24V

LED type	LED Strip
Colour temperature	2700K, 3000K, 4000K
Dimming	Non-dimmable, 1-10V, Dali/Pushdim

Linear LED Strip 24V IP44

LED type	LED Strip
Colour temperature	2700K, 3000K, 4000K
Dimming	Non-dimmable, 1-10V, 0-10V, Dali/Pushdim

Finish Information

(RAL finish available on request)



aluminium
(anodised)



bronze
(brushed anodised)



champagne
(brushed anodised)

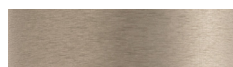

silver bronze
(brushed anodised)

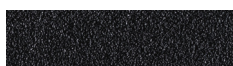

black structure
(powder coating)

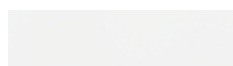

white structure
(powder coating)

Base Profile

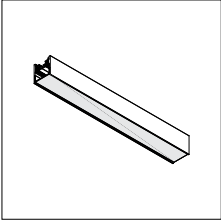

- 93461305** SLD35 PROFILE ALU/M
- 93461309** SLD35 PROFILE WHITE STRUC/M
- 93461332** SLD35 PROFILE BLACK STRUC/M
- 93461341** SLD35 PROFILE ANO CHAMPAGNE/M
- 93461382** SLD35 PROFILE ANO BRONZE/M
- 93461384** SLD35 PROFILE ANO SILVER BRONZE/M

Diffuser

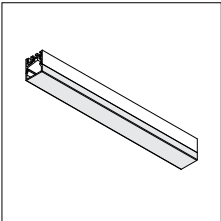

- 93460012** SLD35 DIFFUSER IN/M

Endplate

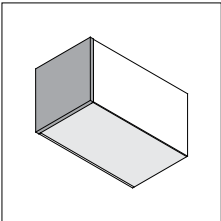

- 93460181** SLD35 ENDPLATE ALU
- 93468118** SLD35 ENDPLATE BRONZE
- 93468117** SLD35 ENDPLATE CHAMPAGNE
- 93468106** SLD35 ENDPLATE SILVER BRONZE
- 93468181** SLD35 ENDPLATE BLACK STRUC
- 93469181** SLD35 ENDPLATE WHITE STRUC

Connection

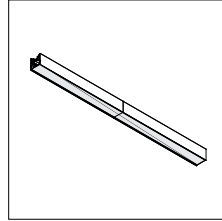

- 93460050** SLD35 CONNECTION 180°

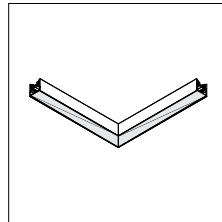

- 93460060** SLD35 CONNECTION 90°

Fixation / Mounting

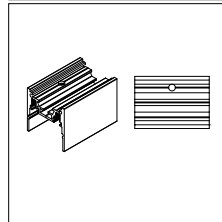

- 93460162** SLD35 SURFACE FIXATION HOLE

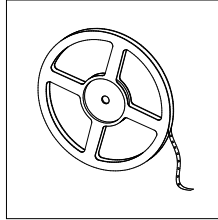

Linear LED Strip 24V

1000lm/m

	2700K	3000K	4000K
mounted/m	93000540	93000541	93000542

2000lm/m

	2700K	3000K	4000K
mounted/m	93000004	93000005	93000006

Lamp type	LED STRIP - diffuser included		
		1000lm/m	2000lm/m
Delivered lumens	2700K	652lm/m	1142lm/m
	3000K	695lm/m	1166lm/m
	4000K	632lm/m	1110lm/m
Connected load	2700K	10.8W/m	18.9W/m
	3000K	10.8W/m	18.9W/m
	4000K	9.6W/m	16.6W/m
Efficacy	2700K	60lm/W	60lm/W
	3000K	64lm/w	62lm/W
	4000K	66lm/W	67lm/W
Binning	3SDCM		
Lifetime	L80 B10 @50000hrs.		

DRIVERS

12405830	LED GEAR 24V 20W
12402030	LED GEAR 24V 20W 1-10V
12409730	LED DRIVER 24V 60W NON-DIM/0/1-10V
12409830	LED DRIVER 24V 100W NON-DIM/0/1-10V
12409930	LED DRIVER 24V 150W NON-DIM/0/1-10V
12405930	LED DRIVER 24V 120W
12405030	LED DRIVER 24V 150W
13550930	LED DRIVER 24V 150W PUSHDIM/DALI
13550830	LED GEAR 24V 100W PUSHDIM/DALI

SUPPLEMENTS

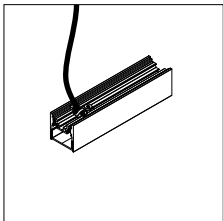

93470505 SLD35 LEDSTRIP 24V CONNECTION SURFACE

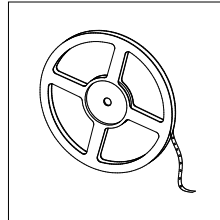

Linear LED Strip 24V IP44

1000lm/m

	2700K	3000K	4000K
mounted/m	93000013	93000014	93000015
not mounted (roll 5m)	93000016	93000017	93000018

2000lm/m

	2700K	3000K	4000K
mounted/m	93000047	93000048	93000049
not mounted (roll 5m)	93000026	93000027	93000028

Lamp type	LED STRIP - diffuser included		
		1000lm/m	2000lm/m
Delivered lumens	2700K	691lm/m	1208lm/m
	3000K	734lm/m	1285lm/m
	4000K	894lm/m	1417lm/m
Connected load	2700K	9.6W/m	16.8W/m
	3000K	9.6W/m	16.8W/m
	4000K	9.6W/m	16.8W/m
Efficacy	2700K	72lm/W	72lm/W
	3000K	77lm/w	77lm/w
	4000K	93lm/W	84lm/W
Binning	3SDCM		
Lifetime	L80 B10 @50000hrs.		

DRIVERS

12405830	LED GEAR 24V 20W
13551130	LED GEAR 24V 60W
13551230	LED GEAR 24V 100W
13551330	LED GEAR 24V 150W
12402030	LED GEAR 24V 20W 1-10V
12409730	LED GEAR 24V 60W 1-10V
12409830	LED GEAR 24V 100W 1-10V
12409930	LED GEAR 24V 150W 1-10V
12405930	LED DRIVER 24V 120W
12405030	LED DRIVER 24V 150W
13550930	LED DRIVER 24V 150W PUSHDIM/DALI
13550830	LED GEAR 24V 100W PUSHDIM/DALI

SUPPLEMENTS

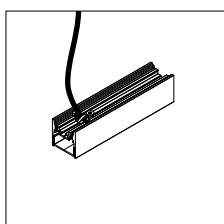

93470505 SLD35 LEDSTRIP 24V CONNECTION SURFACE