

Smart Mask 1.9 1x

US_133500XX

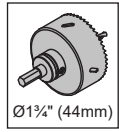

+ driver

driver -

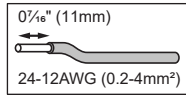

- BLACK (NOIR / NEGRO)
+ RED (ROUGE / ROJO)



+ driver

driver -

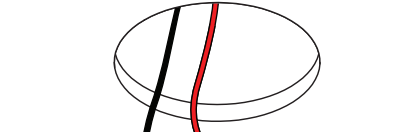
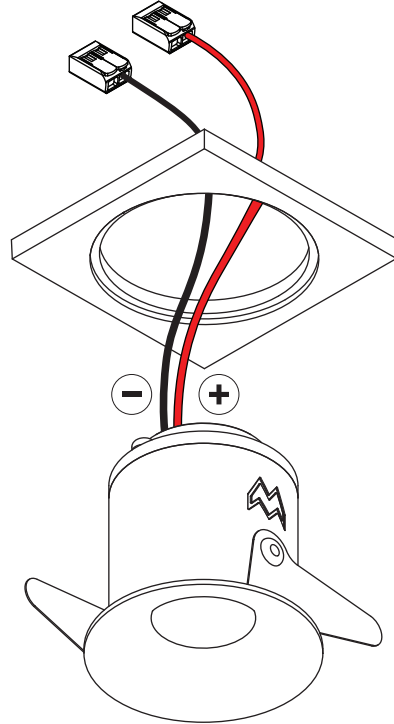

+ driver

driver -

+

-

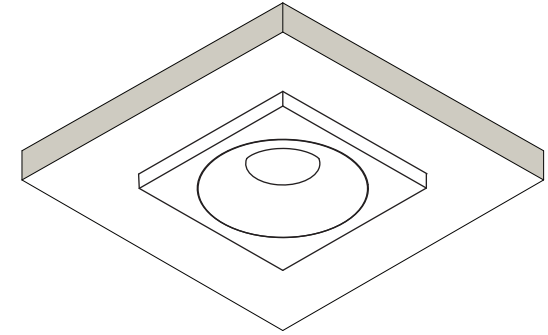

**MIN 90°C SUPPLY CONDUCTORS
LES FILS D'ALIMENTATION 90°C MIN
CONDUCTORES DE ALIMENTACIÓN 90°C Min**

**MAKE SURE POWER IS OFF!
ASSUREZ-VOUS QUE L'ALIMENTATION EST COUPÉE!
ASEGÚRESE DE QUE ESTÁ APAGADO!**

 Replace protective shield when broken. The luminaire shall only be used complete with its protective shield.

 **LIGHT SOURCE - DO NOT TOUCH LED**
Touching the LED can result in permanent damage of the light source. The light source contained in this luminaire shall only be replaced by the manufacturer or his service agent or a similar qualified person.

 **PREVENTING ELECTROSTATIC DAMAGE**
A discharge of static electricity may damage sensitive components. Always be properly grounded when touching leads or circuitry inside the luminaire. Use a wrist strap connected by a ground cord to the housing. Avoid touching the light sources with bare hands.

HAS TO BE USED WITH APPROPRIATE HOUSING:
IC-BOX UAT Smart 1.9
or
NON IC-BOX Smart 1.9

CAN BE COMBINED WITH:
Smart 1.9
or
Smart 1.9 WT

